

**FLUKE®**

**707Ex**  
mA Calibrator

Users Manual

March 2003 Rev 3 5/03(English)  
© 2003 Fluke Corporation, All rights reserved. Printed in USA  
All product names are trademarks of their respective companies.



# Table of Contents

Title	Page
Introduction .....	1
Battery Saver .....	2
Safety Information.....	2
⚠ Warnings and Cautions .....	2
Safety Advice .....	3
Faults and Damage.....	3
Safety Regulations.....	4
Ex-Certification Data .....	4
Symbols .....	4
Front Panel Controls.....	5
Using the mA Sourcing (Output) Modes .....	6
Changing the mA Output Span .....	6
Sourcing mA .....	6
Simulating a Transmitter .....	7
Auto Ramping the mA Output .....	7
Using the SpanCheck Function .....	8
Measuring dc mA.....	8
Measuring dc mA with Loop Power .....	9

HART Compatibility .....	10
Measuring dc Volts .....	10
Maintenance.....	11
In Case of Difficulty.....	11
Cleaning .....	11
Calibration .....	11
Replacing the Battery .....	12
Replaceable Parts .....	13
Fluke Part Numbers.....	13
Approved Batteries .....	13
Accuracy Specifications .....	14
General Specifications .....	14
Contacting Fluke .....	16
<b>Test certificates.....</b>	<b>17</b>

# 707Ex mA Calibrator

## Introduction

### Warning

**Read Safety Information before you use the Calibrator.**

The Fluke 707Ex mA Calibrator (hereafter, "the Calibrator") is a compact and easy to operate sourcing and measuring tool. The Calibrator tests current loops of 0-20 mA or 4-20 mA and measures dc voltage to 28 V. It comes with a set of alligator-clip test leads, a 9 V alkaline battery installed, and this Users manual on a CD.





The Calibrator is ideal for use in confined and restricted spaces within Ex-hazardous areas according to IEC/CENELEC and Factory Mutual.

Calibrator Capabilities

Function	Range	Resolution
Measure V dc	28 V	1 mV
Measure mA dc	0 to 24 mA	1 $\mu$ A
Source mA dc		
Simulate mA dc		
Source loop power	24 V dc	N/A

## Battery Saver

The Calibrator automatically turns off after 30 minutes of inactivity. To reduce this time or disable this feature:

1. With the Calibrator OFF, press .
- P.S. xx** is displayed, where **xx** is the turn-off time in minutes. **OFF** means the power saver is disabled.
2. Turn  to decrease or  to increase the turn-off time.  
To disable, turn  until the display shows **OFF**.
3. The Calibrator resumes normal operation after 2 seconds.

## Safety Information

In this manual a Warning identifies conditions and actions that pose hazards to the user. A Caution identifies conditions and actions that may damage the Calibrator or equipment under test. International symbols used in this manual are identified later in the *Symbols* section.

Read the entire Users Manual and the 707Ex mA Calibrator CCD (Concept Control Drawing) before using the Calibrator.

## Warnings and Cautions

To avoid electric shock, injury, or damage to the Calibrator:

- Use the Calibrator only as described in this Users Manual and the Fluke 707Ex mA Calibrator CCD (Concept Control Drawing) or the protection provided by the Calibrator may be impaired.
- Inspect the Calibrator before use. Do not use it if it appears damaged.
- Check the test leads for continuity, damaged insulation, or exposed metal. Replace damaged test leads.
- Never apply more than 28 V between the input terminals, or between any terminal and earth ground.  
Applying more than 28 volts to the input terminals invalidates the Calibrator's Ex Approval and may result in permanent damage to the unit so it can no longer be used.
- Use the proper terminals, mode, and range for your measuring or sourcing application.
- To prevent damage to the unit under test, put the Calibrator in the correct mode before connecting the test leads.
- When making connections, connect the COM test probe before the live test probe. When disconnecting, disconnect the live probe before the COM probe.

- Never use the Calibrator with the red holster removed.
- Never use the Calibrator with the case open. Opening the case violates Ex Approval
- Make sure the battery door is closed before you use the Calibrator.
- Replace the battery as soon as the **+** (low battery) symbol appears to avoid false readings that can lead to electric shock.
- Remove test leads from the Calibrator before opening the battery door.
- This equipment is specified for use in measurement category I (CAT I) pollution degree 2 environments and should not be used in CAT II, CAT III, or CAT IV environments. Voltage transients should not exceed 300 volts for the CAT I applications where this product is used. Measurement transients are defined in IEC1010-1 as 2  $\mu$ s rise time with a 50  $\mu$ s duration at 50 % of the maximum amplitude height.
- Measurement Category I (CAT I) is defined for measurements performed on circuits not directly connected to the mains.

### ***Safety Advice***

To ensure safe operation of the Calibrator fully observe all instructions and warnings contained in this manual. In case of doubt (due to translation and/or printing errors) refer to the original English manual.

### ***Faults and Damage***

Applying a voltage greater than 28 V to the input of the Calibrator invalidates its Ex Approval and may impair its safe operation in an Ex-hazardous area.

If there is any reason to suspect that the safe operation of the Calibrator has been affected, it must be immediately withdrawn from use, and precautionary measures must be taken to prevent any further use of the Calibrator in an Ex-hazardous area.

The safety features and integrity of the unit may be compromised by any of the following:

- External damage to the housing
- Internal damage to the Calibrator
- Exposure to excessive loads
- Incorrect storage of the unit
- Damage sustained in transit
- Correct certification is illegible
- Using the product with the red holster removed
- Functioning errors occur
- Permitted limitations are exceeded
- Functioning errors or obvious measurement inaccuracies occur which prevent further measurement by the Calibrator

## Safety Regulations











The use of this 707Ex mA Calibrator meets the requirements of the regulations providing that the user observes and applies the requirements as laid down in the regulations and that improper and incorrect use of the unit is avoided.

- Use must be restricted to the specified application parameters.
- Do not open the Calibrator.
- Do not remove or install the battery within the Ex-hazardous area.
- Do not carry additional batteries within the Ex-hazardous area.
- Use only type-tested batteries. The use of any other battery will invalidate the Ex-certification and present a safety risk.
- Do not use the Calibrator in an Ex-hazardous area unless it is completely and securely fitted in its accompanying red holster.
- After using the Calibrator in a non-intrinsically safe protected circuit, a rest time of 3 minutes minimum duration must occur before the Calibrator is taken into and/or used in an Ex-hazardous area.

## Ex-Certification Data









- ATEX Certificate of Conformity: ZELM 02 ATEX 0120 X
- Certification:  II 2 G EEx ia IIC T4
- Permitted for zone1, Equipment Group II, gas group C hazardous gases, vapor or mist, Temperature class T4.
- Factory Mutual, N.I. Class 1 Div. 2 Groups A-D
- Permitted for Division 2 hazardous gases, vapor or mist, Gas Groups A-D







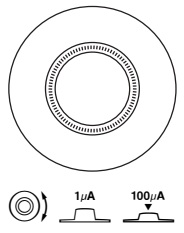

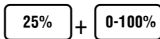

## Symbols

Symbol	Meaning
	ON / OFF button.
	Earth ground
	Caution: Important information. Refer to instruction sheet
	Conforms to ATEX requirements
	Conforms to Factory Mutual requirements
	Double insulated
	Battery
	Conforms to relevant Canadian Standards Association directives. Certification # LR110460-2.
	Conforms to European Union requirements
	Direct current



**Front Panel Controls**

Control	Function
	ON or OFF button.
 +  (Power-on Option)	<p>Press  and  simultaneously to toggle between the mA output spans.</p> <ul style="list-style-type: none"> <li>4 mA to 20 mA = 0 % - 100 % (default)</li> <li>0 mA to 20 mA = 0 % - 100 % (optional)</li> </ul> <p>The selection is saved until it is changed.</p>
	<p>Press to step through modes:</p> <ul style="list-style-type: none"> <li>Source mA</li> <li>Simulate mA</li> <li>Measure mA</li> <li>Loop Power (24 V)</li> <li>Measure V dc</li> </ul>
	<p>Turn  to increase or decrease current output.</p> <p>Current output can be adjusted at a resolution of 1 <math>\mu</math>A or 100 <math>\mu</math>A. (Default is 1 <math>\mu</math>A.)</p> <ul style="list-style-type: none"> <li>To adjust the current in 1 <math>\mu</math>A steps, simply turn the knob.</li> <li>To adjust the current in 100 <math>\mu</math>A steps, <u>press in and turn</u> the knob.</li> </ul>

Control	Function
	<p>Press  to step the current <u>up</u> 25 % of full scale (20 mA).</p> <p>At full scale, press  to step the current <u>down</u> 25 % of full scale.</p>
	<p>Press  +  simultaneously to enter the Auto Ramp mode and select a ramp form.</p> <p>A continuously applied or controlled mA ramping signal is produced in one of three ramp forms.</p> <p> (slow),  (fast), or  (step) identifies the selected ramp form.</p>
	<p>Press  to start the SpanCheck™ at 0 % of selected current span, i.e., 0 mA for 0-20 mA span or 4 mA for 4-20 mA span.</p> <p> is displayed.</p> <p>Press again for 100 % of selected current span.</p>

## Using the mA Sourcing (Output) Modes

The Calibrator outputs current for calibrating and testing 0 to 20 mA and 4 to 20 mA current loops and instruments.

In **SOURCE** mode, the Calibrator supplies the current.

In **SIMULATE** mode, the Calibrator simulates a 2-wire transmitter in an externally powered current loop.

## Changing the mA Output Span

The Calibrator has two mA output spans:

- 4 mA to 20 mA (0 % to 100 %) [default]
- 0 mA to 20 mA (0 % to 100 %) [optional]

To change the output span, turn the Calibrator off. Press **MODE** + **25%** simultaneously. The selected setting is saved until it is changed again.

## Sourcing mA

Use **SOURCE** mode to supply current to a passive circuit.

A path must exist for current to flow between the + and the **COM** terminals. Otherwise, the display flashes when you set an output value.

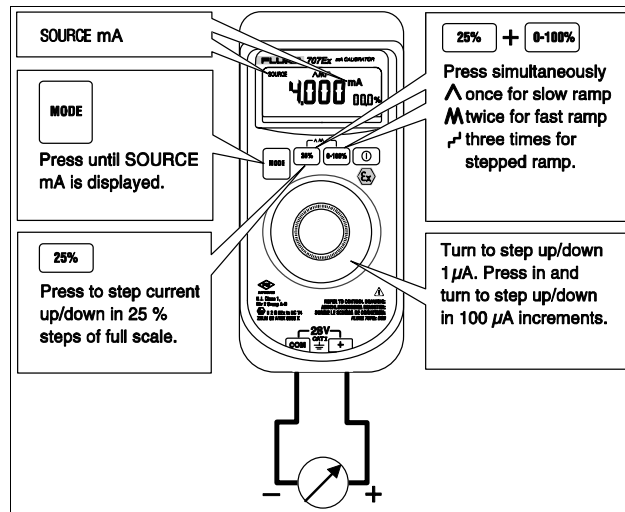

AQV04F.EPS

## Simulating a Transmitter

When simulating the operation of a transmitter, the Calibrator regulates the loop current to a known value selected by you.

A 12 V to 28 V loop supply must be available. Insert the test leads as shown below.

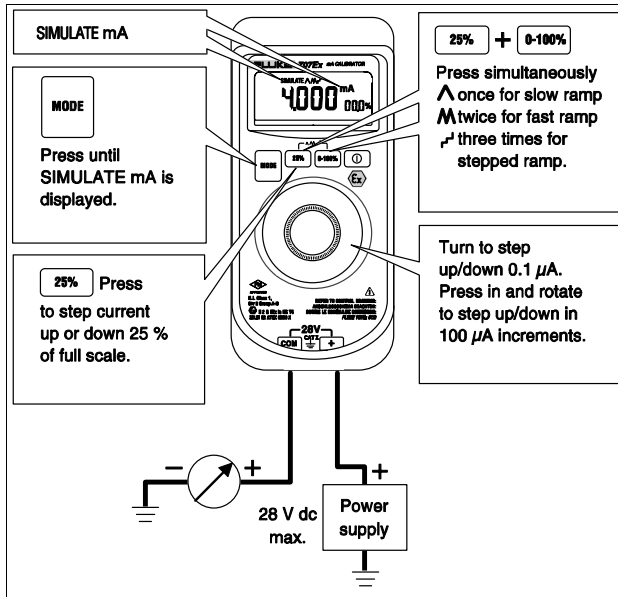

AQV05F.EPS

## Auto Ramping the mA Output

Auto ramping allows you to continuously apply a varying current from the Calibrator to a passive (sourcing) or active (simulate) loop. Your hands remain free to test the transmitter's response.

Press **25%** + **0-100%** simultaneously to enter the Auto Ramp mode and step to a ramp type.

The Calibrator applies or controls a continuously repeating mA signal over a 0-20 mA or a 4-20 mA span in one of three ramp types:

Slow ( $\wedge$ ) 0 % to 100 % to 0 % smooth ramp over 40 sec.

Fast ( $\mathbf{M}$ ) 0 % to 100 % to 0 % smooth ramp over 15 sec.

Step ( $\ulcorner$ ) 0 % to 100 % to 0 % stair-step ramp in 25 % steps, pausing 5 sec at each step.

To exit, press any pushbutton or turn the Calibrator off.

## Using the SpanCheck Function

When in source mode the SpanCheck™ function checks the zero and span points of a transmitter in either **SOURCE** or **SIMULATE** mode.

To select SpanCheck, press .

To exit, press any pushbutton or turn the knob.

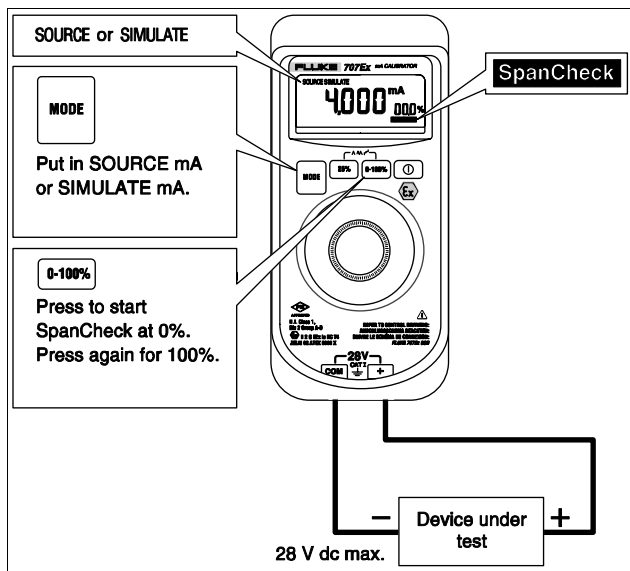

AQV02F.EPS

## Measuring dc mA

### ⚠ Caution

To prevent damage to the unit under test, ensure that the Calibrator is in the correct mode before connecting the test leads.

To measure dc mA:

1. Press  to step to **MEASURE** mode. **MEASURE mA** is displayed.
2. Touch the test probes to the circuit across the load or power source as shown below. Connect the **COM** probe first.

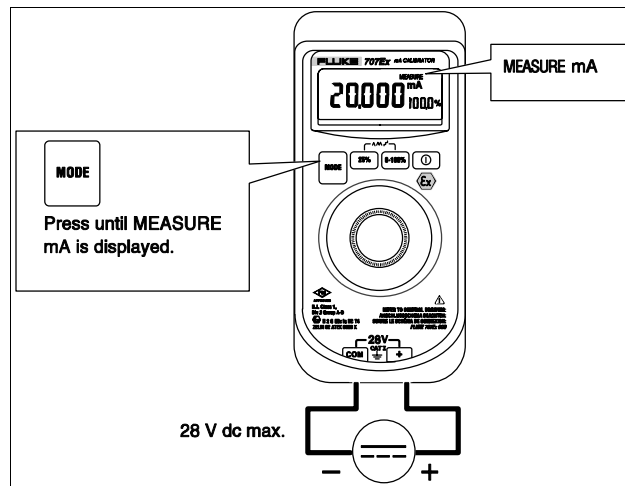

AQV03F.EPS

## Measuring dc mA with Loop Power

### ⚠ Caution

To prevent damage to the unit under test, ensure that the Calibrator is in the correct mode before connecting the test leads.

Loop Power provides power to a transmitter (up to 700  $\Omega$  load) and simultaneously measures the loop current.

To measure dc mA with Loop Power:

1. Press **MODE** to step to **Loop Power** mode.
2. **MEASURE mA** and **Loop Power** are displayed.
3. Touch the test probes to the circuit across the load or power source as shown below. Connect the **COM** probe first.

To exit **Loop Power**, change measurement mode.

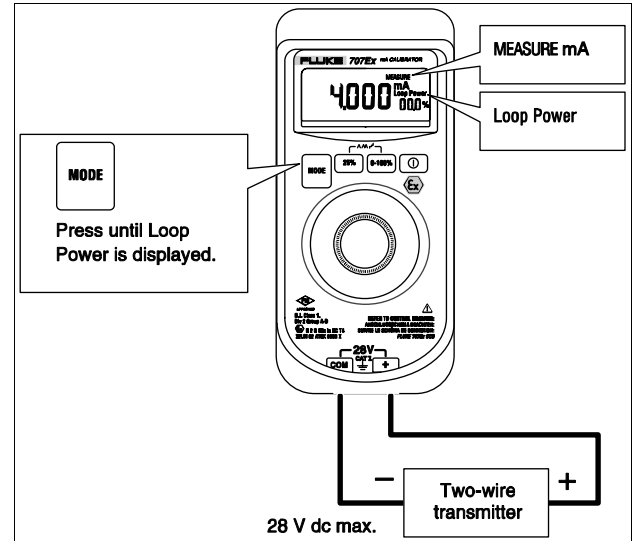

AQV06F.EPS

## HART Compatibility

When in source mode the Calibrator has > 250 Ohms of series resistance and is compatible with HART devices without needing an additional series resistor.

## Measuring dc Volts

### ⚠ Caution

To prevent damage to the unit under test, ensure that the Calibrator is in the correct mode before connecting the test leads.

To measure dc Volts:

1. Press **MODE** to step to MEASURE mode.
2. MEASURE V is displayed.
3. Touch test lead probes across the load or power source. Connect the **COM** probe first.

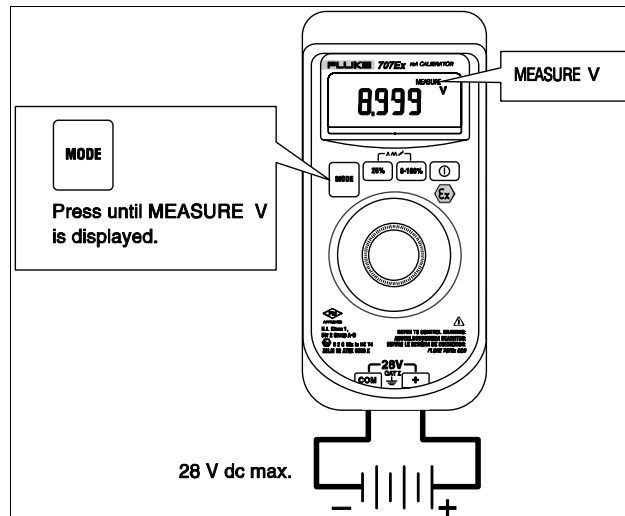

AQV01F.EPS

## **Maintenance**

### **⚠ Warning**

**To avoid electric shock, personal injury, or damage to the Calibrator:**

- **Do not service this product. To maintain the integrity of the Calibrator in explosive atmospheres return the Calibrator to Fluke for all repairs.**
- **Remove any input signals from the test probes prior to removing test leads from the Calibrator.**
- **When servicing the Calibrator, use only specified replacement parts described in the Replaceable Parts section.**
- **Use only the battery specified in the Approved Batteries table.**
- **Do not allow water to get in the case.**

Contact a Fluke Service Center before performing any maintenance procedure not described in this Users Manual.

## **In Case of Difficulty**

- Make sure you are using the Calibrator as described in this Users Manual and the Fluke 707Ex CCD (Concept Control Drawing).
- Check the battery and test leads. If replacement is necessary, use only the specified parts.

Contact a Fluke Service Center if the Calibrator needs repair or does not seem to be operating properly.

If the Calibrator is under warranty, refer to the warranty statement for warranty terms, conditions, and product-return information.

If the warranty has lapsed, the Calibrator will be repaired and returned for a fixed fee.

## **Cleaning**

Periodically wipe the case with a damp cloth and detergent; do not use abrasives or solvents.

## **Calibration**

Calibrate the Calibrator once a year to ensure that it performs according to its specifications.

## Replacing the Battery

**⚠ Warning**

To avoid false readings, which could lead to electric shock or injury, replace the battery as soon as **+■** (low battery indicator) appears on the display.

Do not remove or install the battery within the Ex-hazardous area.

Use only a single 9 V alkaline battery, properly installed, to power the Calibrator. See the table on next page for a list of approved batteries.

To replace the battery:

1. Remove the test probes from the input signal.
2. Press  to turn the Calibrator OFF.
3. Remove the test leads from the input terminals.
4. Remove the red holster.
5. Lift off the battery door on the back of the Calibrator as shown.
6. Remove the battery.
7. Insert the replacement battery and install the battery door. Make sure it is securely in place.
8. Return the Calibrator to its red holster.

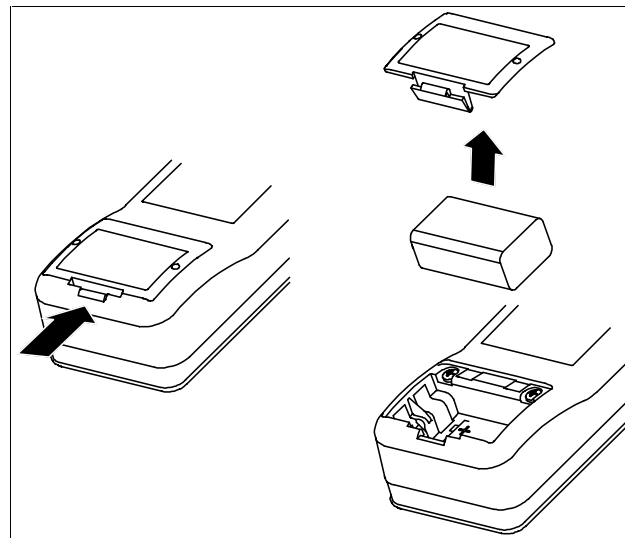

AQV07F.EPS



## Replaceable Parts

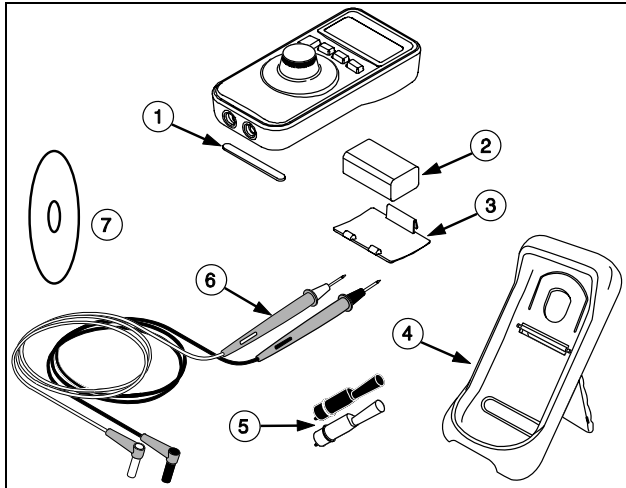

AQV10F.EPS

## Fluke Part Numbers

Item	Part Description	Fluke Part No.	Qty.
1.	Non-skid foot	885884	1
2.	Battery, 9 volt, Alkaline	614487 or see Table below	1
3.	Battery door	665106	1
4.	Red holster, with bail	2040228	1
5.	Alligator clips	AC72	1
6.	Test lead set	TL75	1
7.	Users Manual on CD	2053979	1

## Approved Batteries

Battery Description	Manufacturer	Type
Alkaline, 9 volt	Duracell	6LR61
Alkaline Ultra, 9 volt	Duracell	6LR61
Professional Alkaline Battery Procell, 9 volt	Duracell	6LR61
Alkaline Energizer, 9 volt	Eveready	6LR61
Alkaline Power Line Industrial Battery, 9 volt	Panasonic	6LR61
Alkaline, 9 volt	Daimon	6LR61

## **Accuracy Specifications**

Accuracy is specified for 1 year after calibration at operating temperatures of 18 °C to 28 °C and is given as:

$$\pm ( [ \% \text{ of reading} ] + [ \text{counts} ] )$$

### **MEASURE V dc**

Range: +28 V max

Resolution: 1 mV

Input Impedance: 1 M $\Omega$

Accuracy:  $\pm$  (0.015 % of reading + 2 counts)

### **MEASURE mA dc**

Range: 20 mA (24 mA max)

Resolution: 1  $\mu$ A

Accuracy:  $\pm$  (0.015 % of reading + 2 counts)

### **SOURCE / SIMULATE mA dc**

Range: 0 mA to 20 mA (24 mA max)

Resolution: 1  $\mu$ A

Accuracy:  $\pm$  (0.015 % of reading + 2 counts)

### **Source mode:**

Compliance: To 700  $\Omega$  at 20 mA

### **Simulate mode:**

External loop voltage requirement: 24 V nominal, 28 V maximum, 12 V minimum

### **Loop Power**

Maximum Load: 700  $\Omega$

### **Percent display**

– 25 % to 125 %

### **Input / Output Protection**

Fused; not replaceable

## **General Specifications**

**Maximum voltage between any terminal and earth ground or between any two terminals:**

28 V

### **Storage temperature:**

– 30 °C to 60 °C

### **Operating temperature:**

– 10 °C to 50 °C

**Operating altitude:**

3000 meters maximum

**Temperature coefficient:**

$\pm 0.005$  % of range per °C for temperatures of  $-10$  °C to  $18$  °C and  $28$  °C to  $50$  °C

**Relative humidity:**

95 % up to  $30$  °C;  
75 % up to  $40$  °C  
45 % up to  $50$  °C

**Vibration:**



Random 2 g, 5 to 500 Hz

**Shock:**

1 meter drop test

**Safety Compliance:**

Complies with IEC 61010-1-95 CAT I, 28 V; CSA C22.2 No. 1010-92 NRTL; ANSI/ISA S82.02.01-1994;

 Directive 94/9/EG and  NEC 500:  $U_o = 27.6$  V,  
 $I_o = 96.13$  mA,  $C_o = 76$  nF,  $L_o = 2.5$  mH,  $U_i = 30$  V,  
 $I_i = 24$  mA,  $C_i = 10$  nF,  $L_i = 0$  mH

**CE:**

Complies with EN61010-1 and EN61326

**Power requirements:**

Single 9 V battery  
(See Approved Batteries table in Replaceable Parts section, page 13)

**Battery life (typical):**

SOURCE mode: 18 hours; 12 mA into  $500 \Omega$ ;  
MEASURE / SIMULATE mode: 50 hours

**Size:**

69.85 mm (W) x 142.87 mm (L) x 50.80 mm (H)  
[ 2.75 in (W) x 5.625 in (L) x 2.00 in (H) ]

With red holster and Flex-Stand:

76.20 mm (W) x 158.75 mm (L) x 54.61 mm (H)  
[ 3.00 in (W) x 6.25 in (L) x 2.15 in (H) ]

**Weight:**

0.28 kg (0.62 lb)

With red holster and Stand: 0.42 kg (0.93 lb)

## **Contacting Fluke**

To contact Fluke for product information, operating assistance, service, or to get the location of the nearest Fluke distributor or service center, call:

1-888-99-FLUKE (1-888-993-5853) in U.S.A

1-800-36-FLUKE in Canada

+31-402-675-200 in Europe

+81-3-3434-0181 Japan

+65-738-5655 Singapore

+1-425-446-5500 from other countries

Or visit Fluke's web site at: [www.fluke.com](http://www.fluke.com).

Register your Calibrator at: [register.fluke.com](http://register.fluke.com).

Address correspondence to:

Fluke Corporation  
P.O. Box 9090,  
Everett, WA 98206-9090  
U.S.A.

Fluke Europe B.V.  
P.O. Box 1186,  
5602 BD Eindhoven  
The Netherlands



(1) **EC type approval test certificate**

- (2) Devices and protection systems for proper designated use  
in areas with an increased risk of explosion – Directive 94/9/EC  
(3) EC type approval test certificate number

**ZELM 02 ATEX 0120 X**

- (4) Device: **Explosion-protected mA calibrator 707Ex**  
(5) Manufacturer: **eocom Instruments GmbH**  
(6) Address: **D-97959 Assamstadt**  
(7) The design of this device and its various approved embodiments are defined in the attachment to this type approval test certificate.  
(8) As the nominated body no. 0820 in accordance with article 9 of the EC council directive dated March 23, 1994 (94/9/EC), the Testing and Certification Body ZELM Ex certifies conformance with the basic health and safety requirements for the design and construction of devices and protection systems for proper designated use in areas with an increased risk of explosion in accordance with Appendix II of the directive.  
The results of the test are documented in the confidential test report no. ZELM Ex 0510217162.  
(9) The basic health and safety requirements are met by virtue of conformance with  
**EN 50 014: 1997+A1+A2 EN 50 020: 1994**  
(10) If the certification number is followed by an "X", then this indicates that special conditions exist for the safe operation of the device. These special conditions are contained in the attachment to this certificate.  
(11) This EC type approval test certificate only refers to the construction/design, checking and testing of the specified device or protection system in accordance with directive 94/9/EC. Further requirements contained in this directive may apply with regard to the manufacturing process and the supply of the device or protection system. Such requirements are not covered by this certification.  
(12) The device must be labelled with the following information:

**II 2 G EEx ia IIC T4**

Certification body: **ZELM Ex**  
Dipl.-Ing. Harald Zelm

Brunswick, 28.02.2003



**Attachment**

- (13) **EC type approval test certificate ZELM 02ATEX 0120 X**  
(14) **Description of the device**  
(15)

The explosion-protected mA calibrator 707Ex serves as a compact source and measuring instrument for mobile measurements of current loops (0...24 mA) and DC voltages (up to 28 V) in areas with an increased risk of explosion as well as in areas with no increased risk of explosion. The device is equipped with a power supply in the form of a battery of type 6LR61. This battery must only be changed outside the area with increased risk of explosion. Within the ex-area the device must be carried in the designated holster.

Electrical data

Power supply circuit

from an integral battery, EEx Ia IIC

The internal circuits are intrinsically safe.

Measuring circuit

Type of ignition protection: intrinsically safe, EEx ia IIC for connection to certified intrinsically safe circuits

Maximum values:

a) Current measuring circuit, active (0...24 mA) (linear characteristic)	U <sub>0</sub> = 27.6 V DC I <sub>0</sub> = 96.9 mA
Max. perm. external capacitance	C <sub>0</sub> = 76 nF
Max. perm. external inductance	L <sub>0</sub> = 2.5 mH
b) Voltage measurement (0...28 V)	U <sub>I</sub> = 30 V DC I <sub>I</sub> = 24 mA
Effective internal capacitance	C <sub>I</sub> = 10 nF
The effective internal inductance is negligibly small.	

Permitted ambient temperature -10 °C to +50 °C

Measurements on non-intrinsically safe circuits

Measurement inputs	Maximum values:	U = 30 V DC I = 24 mA
--------------------	-----------------	--------------------------

Note:

The operating instructions must be followed.

The battery must be changed outside the ex-area.

Within the ex-area the device must be carried in the designated holster.

**Attachment to EC type approval test certificate ZELM 02 ATEX 0120 X**

- (16) Test report no.  
ZELM Ex 0510217162  
(17) Special conditions  
The battery must be changed outside the ex-area. Only the battery type(s) listed in the operating instructions must be used.  
Within the ex-area the device must be carried in the designated holster.  
(18) Basic health and safety requirements  
satisfied by virtue of the standards  
Certification body: **ZELM Ex**  
Dipl.-Ing. Harald Zelm

Brunswick, 28.02.2003





FM Approvals  
1151 Boston-Providence Turnpike  
P.O. Box 9102 Norwood, MA 02062 USA  
T: 781 762 4300 F: 781 762 9375 www.fmglobal.com

# CERTIFICATE OF COMPLIANCE

## HAZARDOUS (CLASSIFIED) LOCATION ELECTRICAL EQUIPMENT

This certificate is issued for the following equipment:

### **707-Ex. Loop Calibrator.**

NI-AIS / 1 / 2 / ABCD / T4 Ta = 50 °C

NI-ANI / 1 / 2 / ABCD / T4 Ta = 50 °C

AIS / 1 / 2 / ABCD / - Fluke 707Ex CCD Entity

ANI / 1 / 2 / ABCD / - Fluke 707Ex CCD Nonincendive Field Wiring

#### Entity Parameters:

Vmax = 30 V, Imax = 250 mA, Pi = 0.7 W, Ci = 10 nF, Li = 0

Voc = 27.6 V, Isc = 26.4 mA, Po = 0.7 W, Co (Ca) = 76 nF, Lo (La) = 2.5 mH

#### Nonincendive wiring parameters

Vmax = 30 V, Ci = 10 nF, Li = 0

Voc = 27.6, Isc = 26.4 mA, Co = 200 nF, Lo = 86 mH

#### Equipment Ratings:

Suitable for use in Class I, Division 2, Groups A, B, C, and D hazardous (classified) locations with intrinsically safe connections for Class I, Division 1, Groups A, B, C, and D and with nonincendive field wiring connections hazardous (classified) locations

#### Approved for:

ecom instruments  
D-97959 Assamstadt Germany



This certifies that the equipment described has been found to comply with the following FM Approval Standards and other documents:

Class 3600	1998
Class 3610	1999
Class 3610	1999

Original Project ID: 3016196

FM Approval Granted: May 9, 2003

Subsequent Revision Reports / Date FM Approval Amended

Report Number	Date	Report Number	Date
---------------	------	---------------	------

FM Global Technologies LLC

Nicholas P. Ludlam  
Technical Team Manager

May 12, 2003  
Date